

SEQUE

DESIGNS

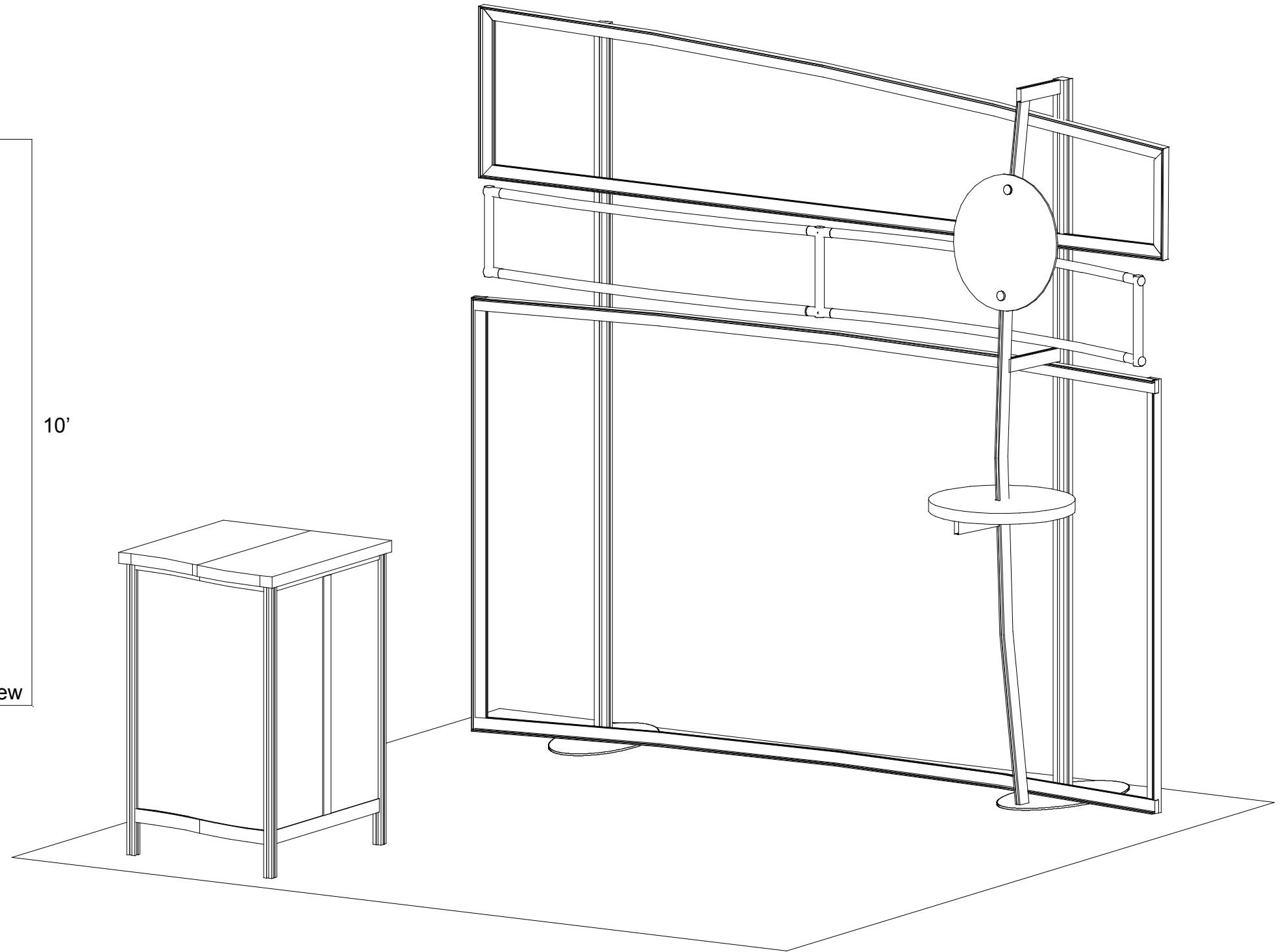
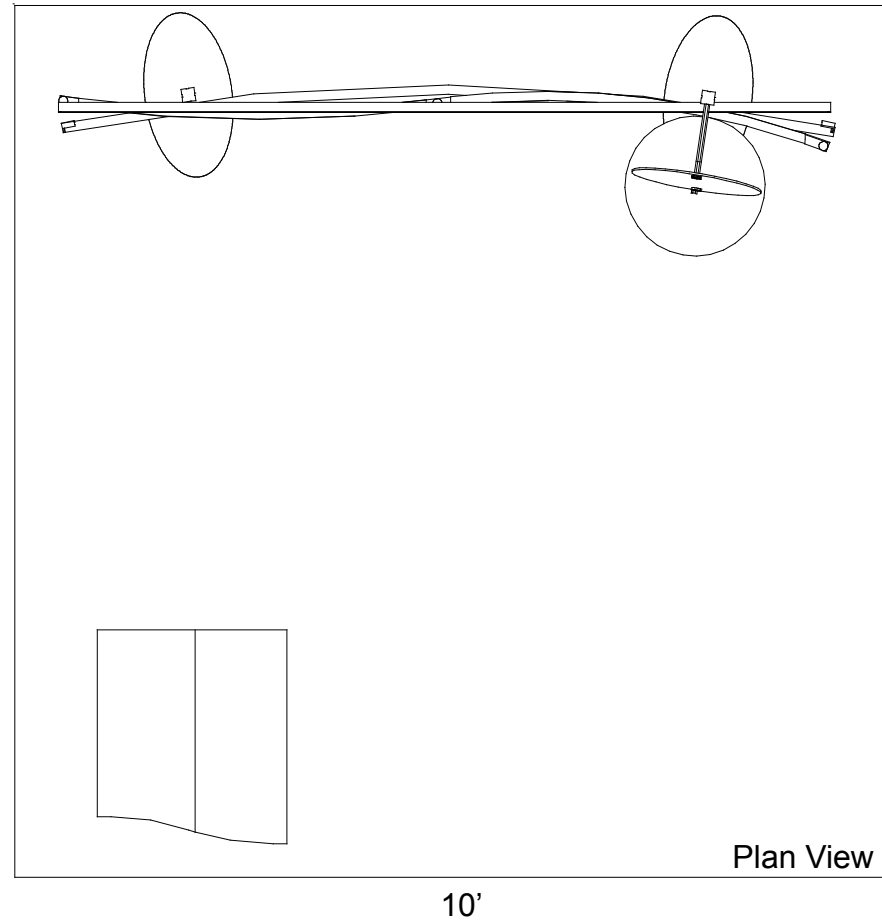

WHEN DISASSEMBLING ALUMINUM EXTRUSION, TIGHTEN ALL SETSCREWS AND LOCKS TO PREVENT LOSS DURING SHIPPING

visionary™ DESIGNS

Using Your Setup Instructions

The Visionary Designs Setup Instructions are created specifically for your configuration. They are laid out sequentially, including an exploded view of the entire display, and then a logical series of detailed steps to assemble the main structure and components. We encourage you to study the instructions **before** attempting to assemble your exhibit.

Each page reminds you to tighten the setscrews after disassembling your exhibit to prevent loss of the locks and setscrews (see below in RED). This is **VERY IMPORTANT**.

Cleaning and Packing Your Display

- 1) Use care when cleaning aluminum extrusion or acrylic inserts. Use only non-abrasive cleaners.
- 2) When cleaning laminate inserts or countertops, use mild cleansers and a soft material such as cotton.
- 3) Keep all display components away from extreme heat and long exposure to sunlight to avoid warping and fading.
- 4) Retain all packing material. It will make re-packing much easier and will reduce the likelihood of shipping damage.



The Tool

Most Visionary Designs exhibits can be assembled with the supplied Hex Key Tool. Occasionally, a flat head screwdriver may be required.



Typical Connection

Most horizontal extrusion connections have a patented expandable lock. This lock inserts into the groove of an opposing extrusion. Tightening the lock with the Hex Key Tool expands the lock and creates a strong positive connection.



Typical Connection (cont'd)

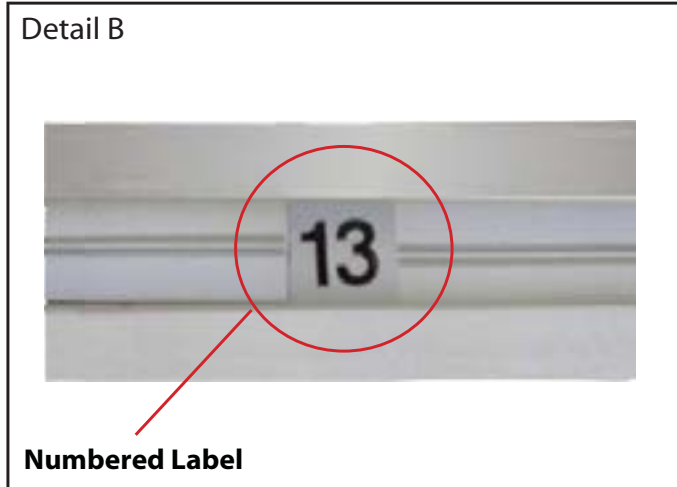

Detail B

Numbered Label

Each extrusion contains a numbered label which corresponds with setup instructions. The label is located within a groove of the extrusion (when possible). With Visionary Designs the labels contain Black numbers unless otherwise specified.



Detail C

Horizontal Inline Connection (remove only one setscrew)

Remove only (1) setscrew when disassembling. Replace setscrew in extrusion after assembling it. Before packing, replace setscrew in extrusion to avoid losing it.

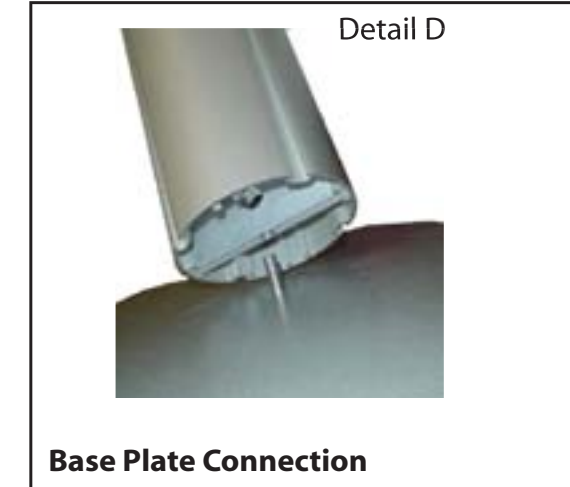

Detail D

Base Plate Connection

Attach base plate to round or square vertical extrusion using the bolt provided. Be careful not to strip the threads.

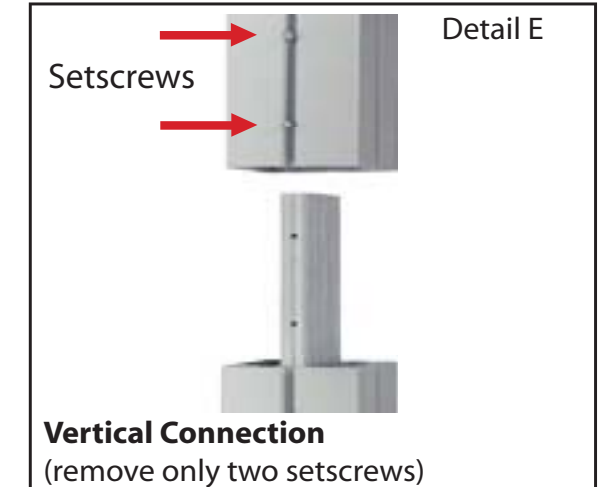

Detail E

Vertical Connection
(remove only two setscrews)

When vertical extrusions are packed in portable cases rather than crates or tubs, they must be broken down into smaller sections which then require assembly.

Remove only (2) setscrews when disassembling. Replace setscrews in extrusion after assembling it. Before packing, replace setscrews in extrusion to avoid losing them.

WHEN DISASSEMBLING ALUMINUM EXTRUSION, TIGHTEN ALL SETSCREWS AND LOCKS TO PREVENT LOSS DURING SHIPPING

Item	Qty.	Description
1	1	Base Plate
2	1	47.875" Vertical Extrusion
3	1	47.875" Vertical Extrusion
4	1	Base Plate
5	1	47.875" Vertical Extrusion
6	1	47.875" Vertical Extrusion
7	1	47.576" Curved Vertical Extrusion
11	2	Counter Support

Steps:

- 1) Connect lower verticals [2, 5 and 7] to base plates [1 and 4].
- 2) Connect upper verticals to lowers verticals [3 to 2 and 6 to 5].
- 3) Connect shelf supports [11] to curved vertical [7], then slide counter top on vertical [7] and rest on top of supports.

Screwcaps and connectors for graphic frame attachment stay attached to verticals when shipping in jugged cases

Connection Bar C

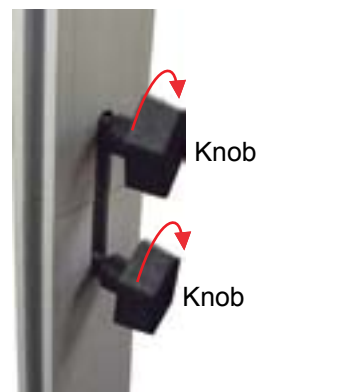

Slide connecting bar between verticals, tighten knobs to secure

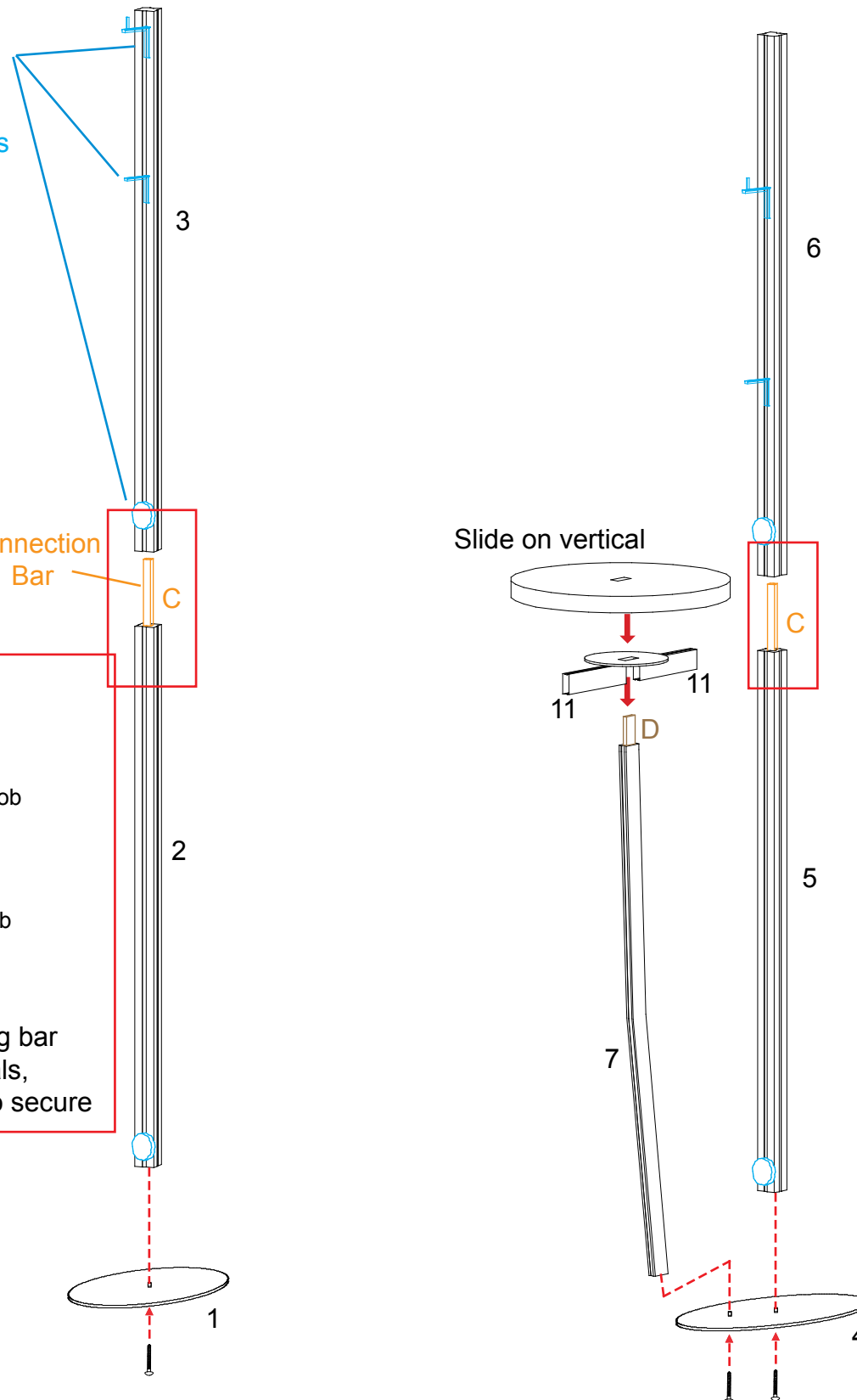

Slide on vertical

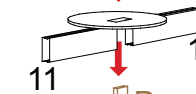

7

5

6

*** Round plate and horizontals #11 stay assembled when shipping**

Loosen screw and remove #11 if needed for easier installation

Stoppers

Slide slot on round plate on extrusion #7 and slide locks located on inner end of extrusions #11's into grooves of extrusion #7 atop stoppers, then tighten setscrews to secure

Slide screws located on underside of counter into holes on round plate and secure with wing nuts

WHEN DISASSEMBLING ALUMINUM EXTRUSION, TIGHTEN ALL SETSCREWS AND LOCKS TO PREVENT LOSS DURING SHIPPING

Item	Qty.	Description
12a/12b/12c	1/1/1	35.6954" TSP Horizontal Extrusion
13a/13b/13c	1/1/1	35.6954" TSP Horizontal Extrusion
14a/14b	1	29" TSP Vertical Extrusion
15a/15b	1	29"h TSP Vertical Extrusion

- Steps:
- 1) Connect TSP pieces together [a to b to c]
 - 2) Assemble SEG frame assemblies together.

***** Must apply SEG graphic AFTER attaching frame to backwall verticals *****

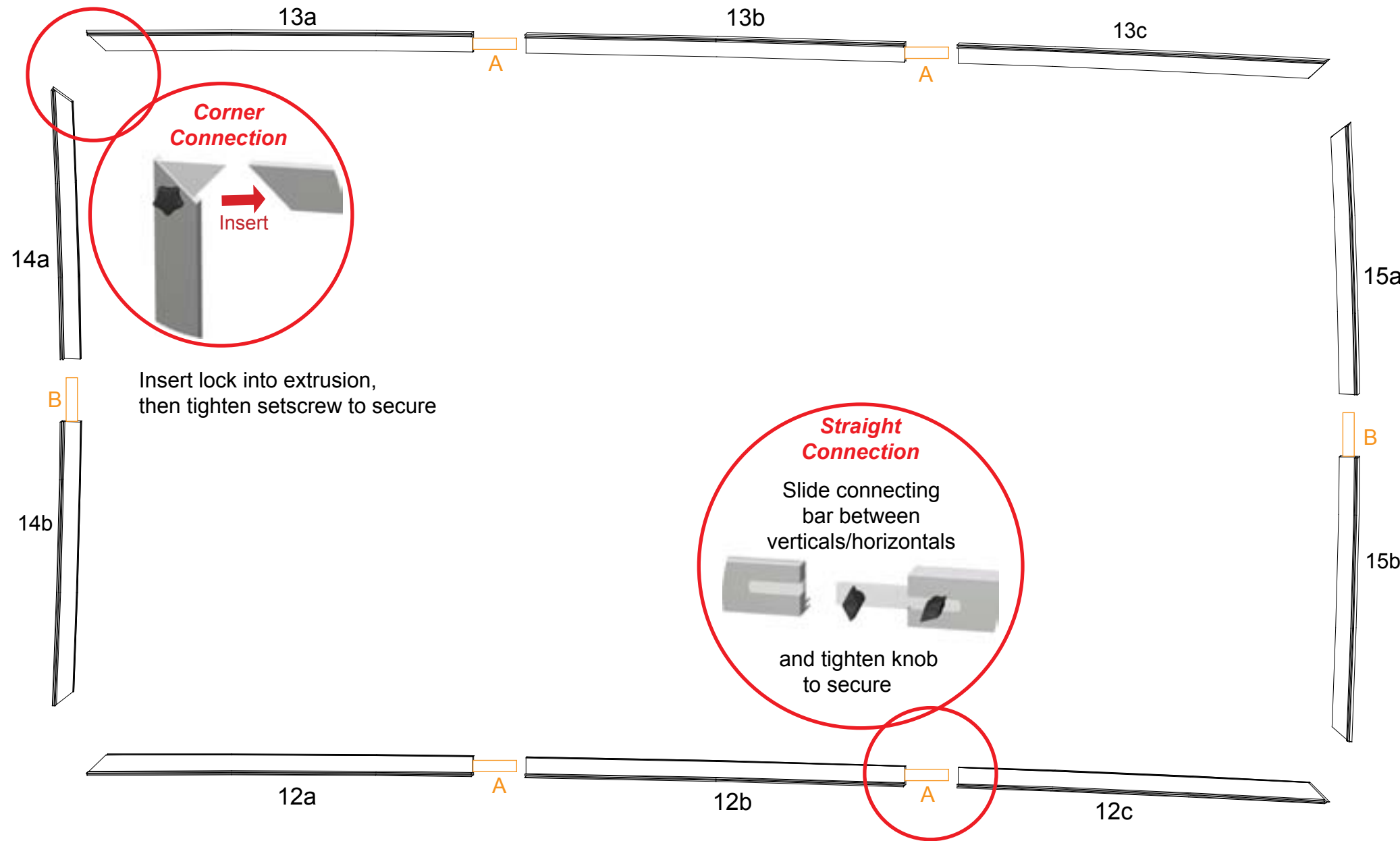

Graphic: To Ensure Proper Fit

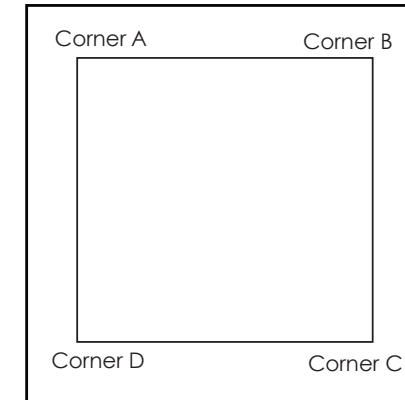

It is important to first insert graphic into each alternater corner then to the sides of the frame. If this is not done, graphic will not fit into the frame correctly.

Step 1
Insert corner A.
Turn edge of graphic so silicon welt is perpendicular to face of graphic. Insert narrow side of welt with fabric to outside into the channel. Repeat for other side of this corner.



Step 2
Repeat Step 1 for opposite corner C, then insert corner D, to complete the installation of the corners.

Step 3
Once all corners are inserted, press one silicon edge into channel from corners and work toward the center. Make sure welt is fully inserted into channel. Continue until all sides are done. Smooth out edges of graphic.

Graphic Removal



To remove the graphic from the frame, locate the fabric pull tab. Gently pull up on the tab to remove the fabric.

WHEN DISASSEMBLING ALUMINUM EXTRUSION, TIGHTEN ALL SETSCREWS AND LOCKS TO PREVENT LOSS DURING SHIPPING

Item	Qty.	Description
16a/16b/16c	1/1/1	35.33" TSP Horizontal Extrusion
17a/17b/17c	1/1/1	35.6954" TSP Horizontal Extrusion
18	1	23" TSP Vertical Extrusion
19	1	15" TSP Vertical Extrusion

- Steps:
- 1) Connect TSP pieces together [a to b to c]
 - 2) Assemble SEG frame assemblies together.
 - 3) Apply SEG graphic to assembled frame.

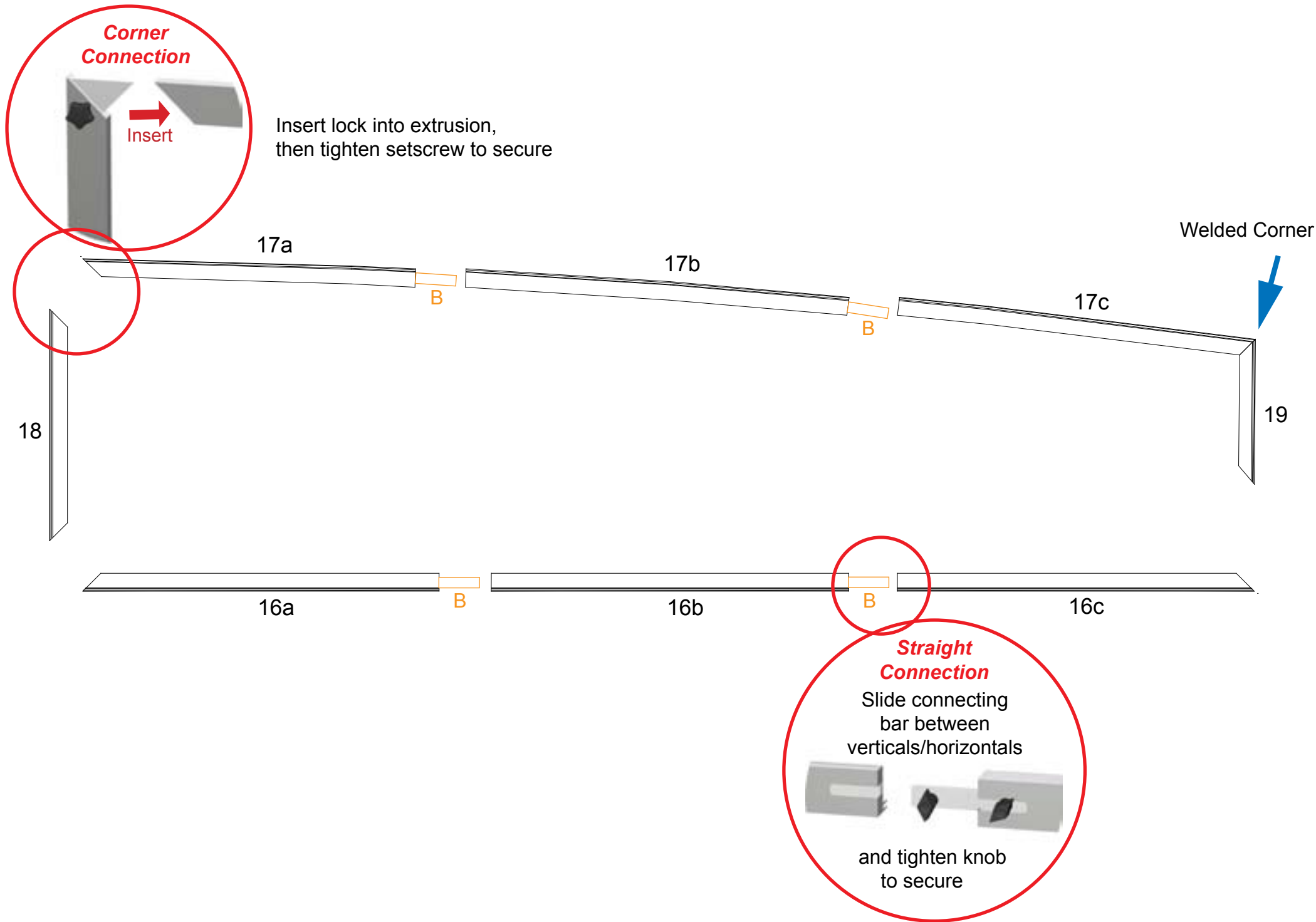

Graphic: To Ensure Proper Fit

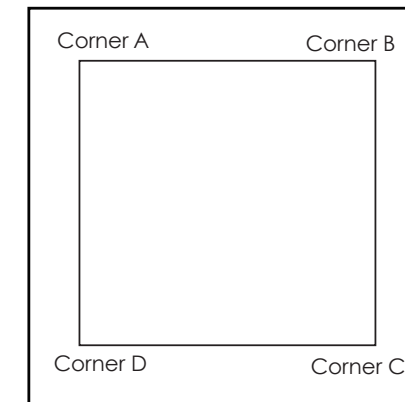

It is important to first insert graphic into each alternater corner then to the sides of the frame. If this is not done, graphic will not fit into the frame correctly.

Step 1
Insert corner A. Turn edge of graphic so silicon welt is perpendicular to face of graphic. Insert narrow side of welt with fabric to outside into the channel. Repeat for other side of this corner.



Step 2
Repeat Step 1 for opposite corner C, then insert corner B, followed by corner D, to complete the installation of the corners.



Step 3
Once all corners are inserted, press one silicon edge into channel from corners and work toward the center. Make sure welt is fully inserted into channel. Continue until all sides are done. Smooth out edges of graphic.

Graphic Removal



To remove the graphic from the frame, locate the fabric pull tab. Gently pull up on the tab to remove the fabric.

WHEN DISASSEMBLING ALUMINUM EXTRUSION, TIGHTEN ALL SETSCREWS AND LOCKS TO PREVENT LOSS DURING SHIPPING



Using Your Setup Instructions

The Aero Overhead Sign Setup Instructions are created specifically for your configuration. They include an exploded view of the frame which is sequentially numbered. We encourage you to study the instructions before attempting to assemble your exhibit.

Connections are kept very simple: no tools. Everything assembles with push-button connectors and pre-connected horizontal sections.

Cleaning and Packing Your Display

- 1) Use care when cleaning aluminum extrusion or acrylic inserts. Use only non-abrasive cleaners.
- 2) Retain all packing material. It will make re-packing much easier and will reduce the likelihood of shipping damage.

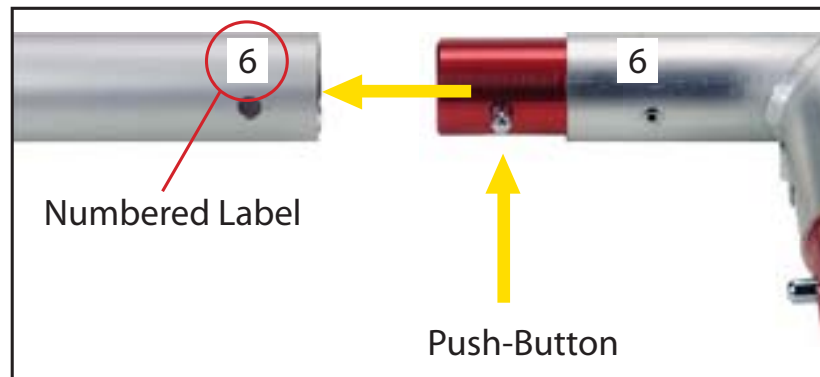

Connections are made by holding the button down and sliding the red tube into opposing tube until the connection is made. To disassemble push button and pull or twist extrusions apart.

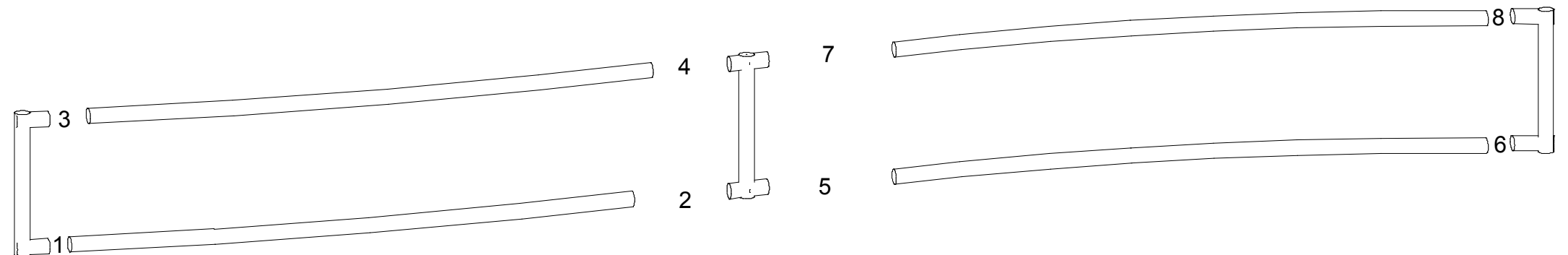
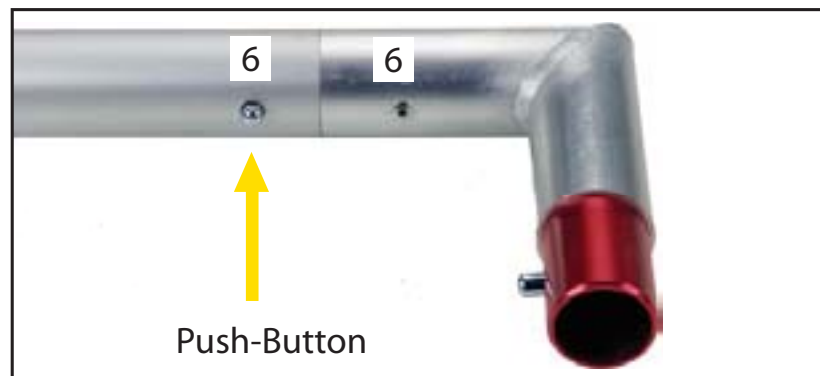

Steps:
 Assemble frame together in numerical order.
 Apply pillowcase graphic to assembled frame.

WHEN DISASSEMBLING ALUMINUM EXTRUSION, TIGHTEN ALL SETSCREWS AND LOCKS TO PREVENT LOSS DURING SHIPPING

Item	Qty.	Description
8	1	47.576" Curved Vertical Extrusion
9	1	8" Horizontal Extrusion
10	1	10.375" Horizontal Extrusion

Steps:

- 1) Attach assembled large SEG frame to vertical extrusions using screwcaps provided.
- 2) Apply SEG graphic to frame.
- 3) Attach horizontal [10] to vertical [6] atop large frame.
- 4) Attach center frame with pillowcase graphic to backwall verticals by slide connector pieces into groove of vertical from top.
- 5) Attach upper frame to backwall verticals and secure with connectors as shown.
- 6) Attach curved vertical [8] to bottom curved vertical [7], see detail E on General Info Page.
- 7) Lock front end of horizontal [11] to back of vertical [8].
- 8) Attach round sign at vertical [8] as shown.
- 9) Attach horizontal [9] to vertical [5] and lock top of vertical [8] to bottom of horizontal [8].

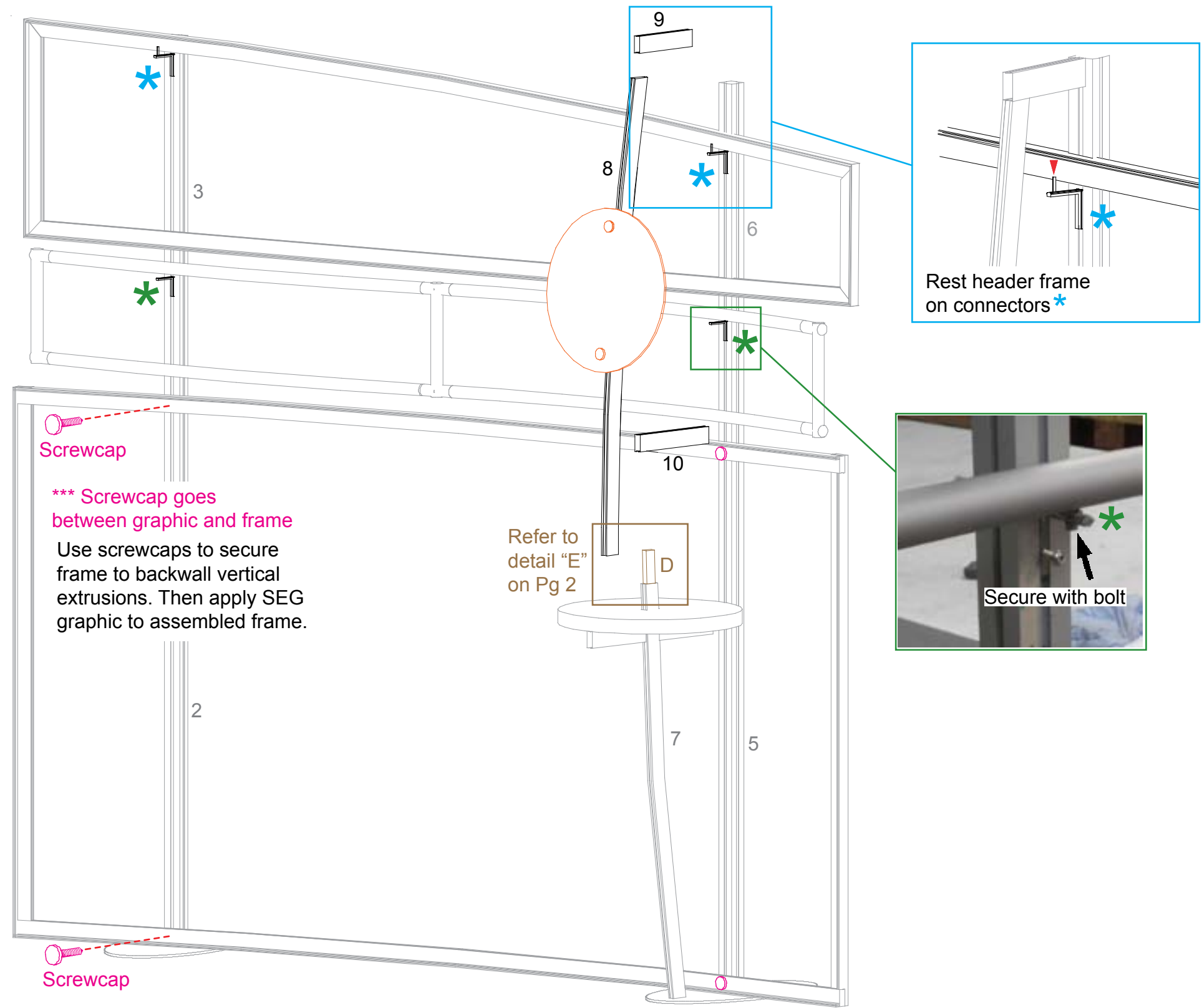
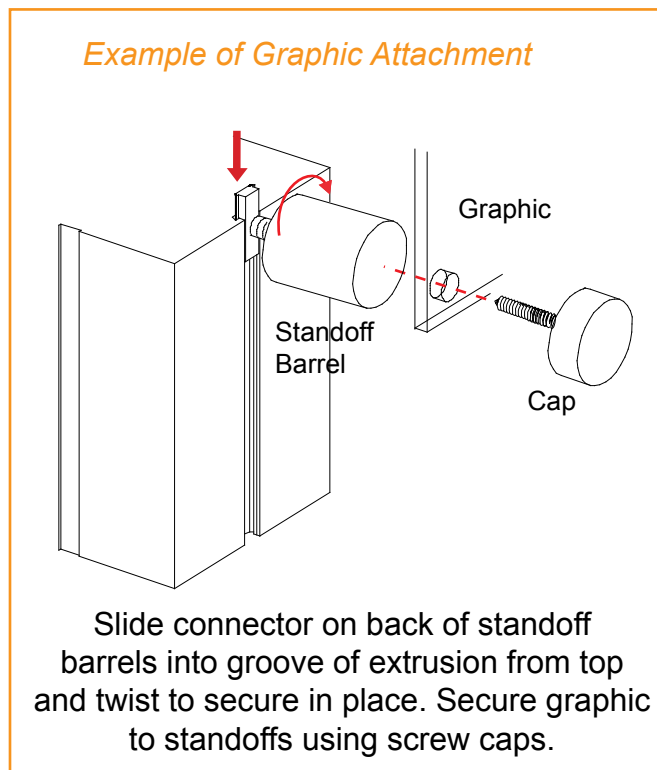

WHEN DISASSEMBLING ALUMINUM EXTRUSION, TIGHTEN ALL SETSCREWS AND LOCKS TO PREVENT LOSS DURING SHIPPING

Item	Qty.	Description
20	1	40" Vertical Extrusion
21	1	40" Vertical Extrusion w/ Hinges
22	1	40" Vertical Extrusion w/ Stopper
23	1	40" Vertical Extrusion
24	2	S-curved Horizontal
25	1	22" Horizontal Extrusion
26	2	22.264" Horizontal Extrusion
27	1	25.678" Horizontal Extrusion
28	1	32" Vertical Extrusion
29	1	22" Horizontal Extrusion
30	1	25.678" Horizontal Extrusion

Steps:

- 1) Connect lower horizontal extrusions between verticals approx at 4.5" from ground on stoppers as shown.
- 2) Attach door where indicated.
- 3) Place insert infills and attach vertical [28] where indicated.
- 4) Connect upper horizontal extrusions between verticals as shown.
- 5) Velcro shelf supports to inside of assembled pedestal atop floor.
- 6) Set internal shelf on shelf supports.
- 7) Set counter top on assembled pedestal.

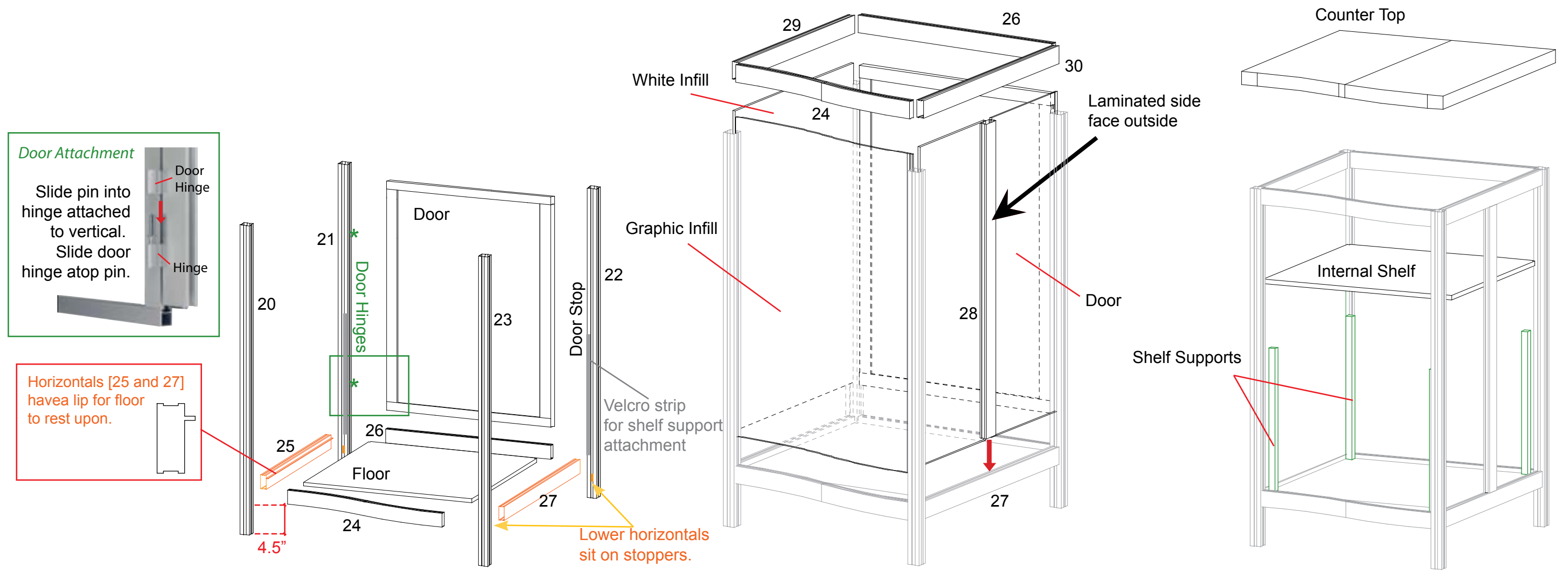

WHEN DISASSEMBLING ALUMINUM EXTRUSION, TIGHTEN ALL SETSCREWS AND LOCKS TO PREVENT LOSS DURING SHIPPING

Top View of each Case

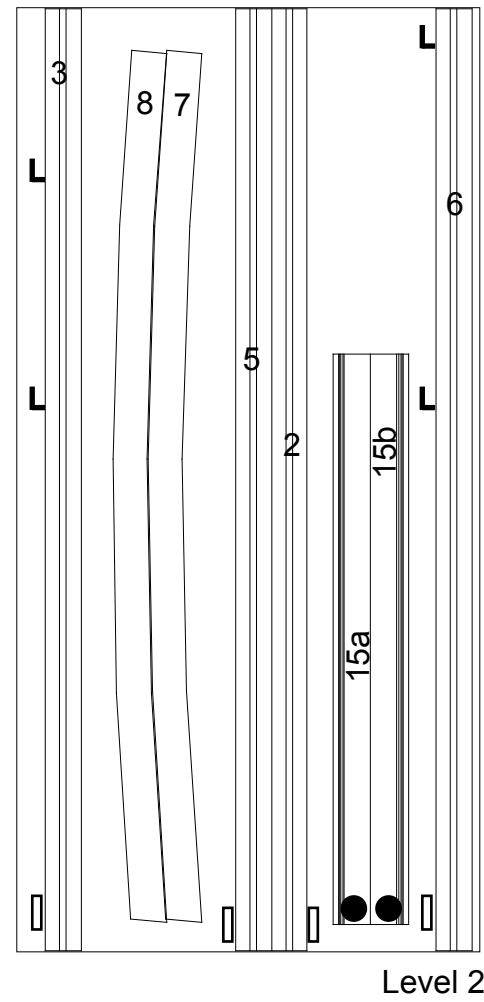
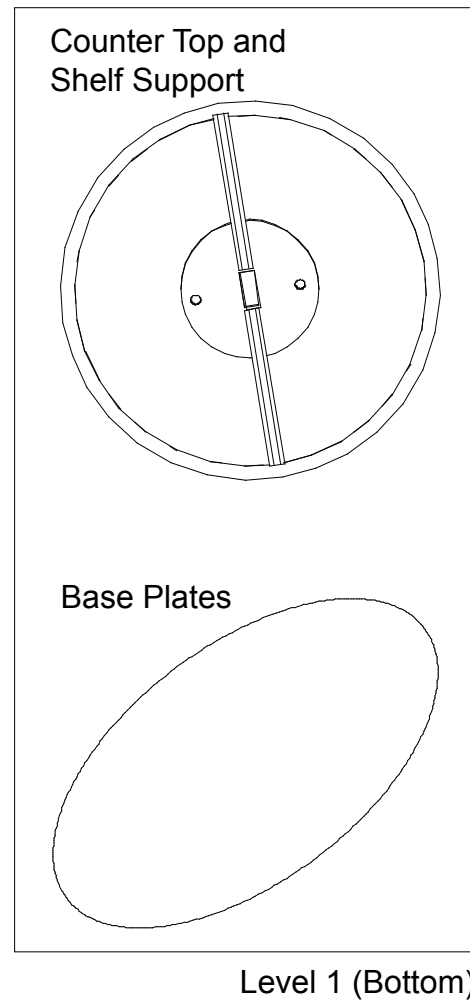

WHEN DISASSEMBLING ALUMINUM EXTRUSION, TIGHTEN ALL SETSCREWS AND LOCKS TO PREVENT LOSS DURING SHIPPING

Top View of each Case

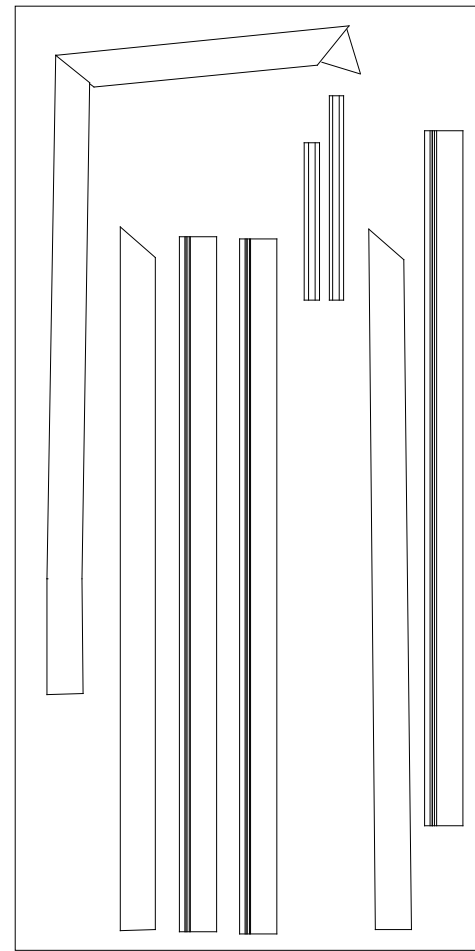

Level 1 (Bottom)

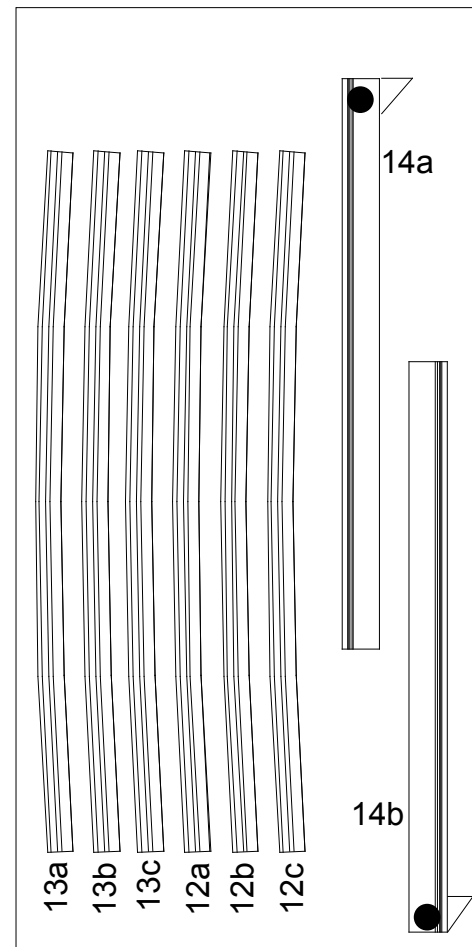

Level 2

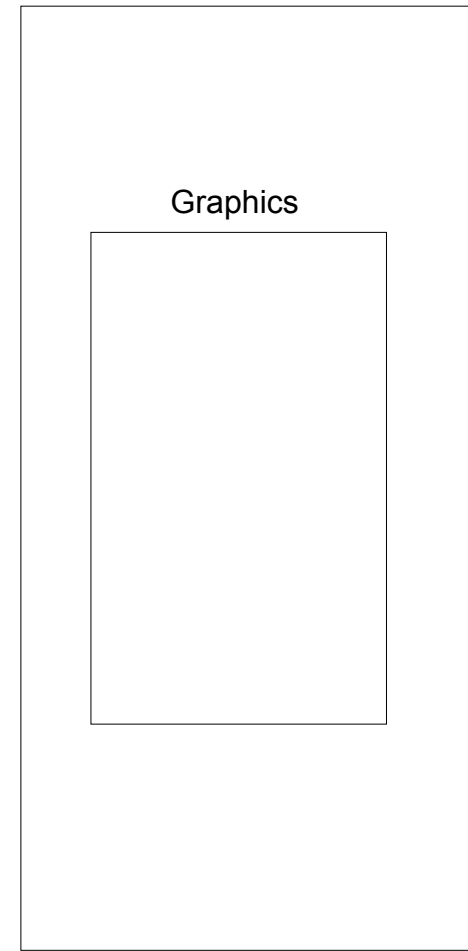

Level 3

WHEN DISASSEMBLING ALUMINUM EXTRUSION, TIGHTEN ALL SETSCREWS AND LOCKS TO PREVENT LOSS DURING SHIPPING

Top View of each Case

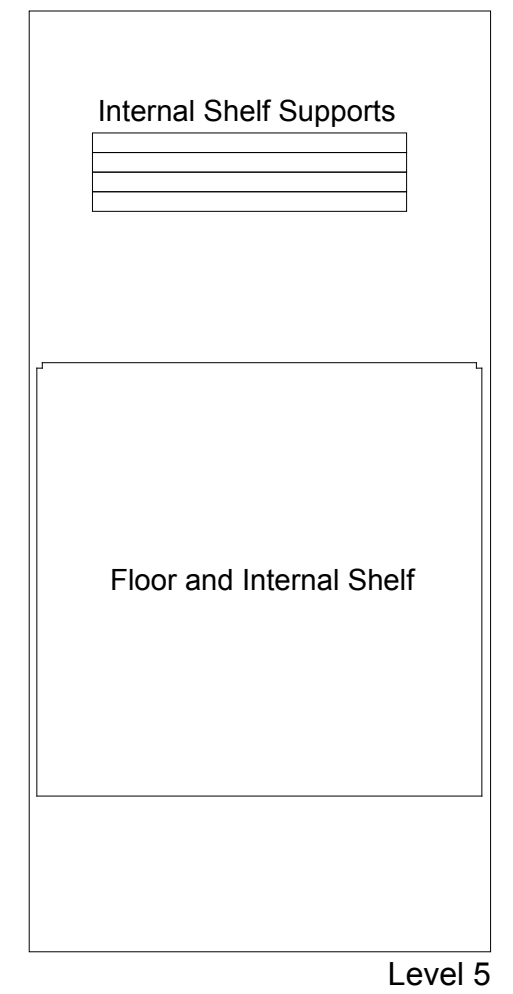
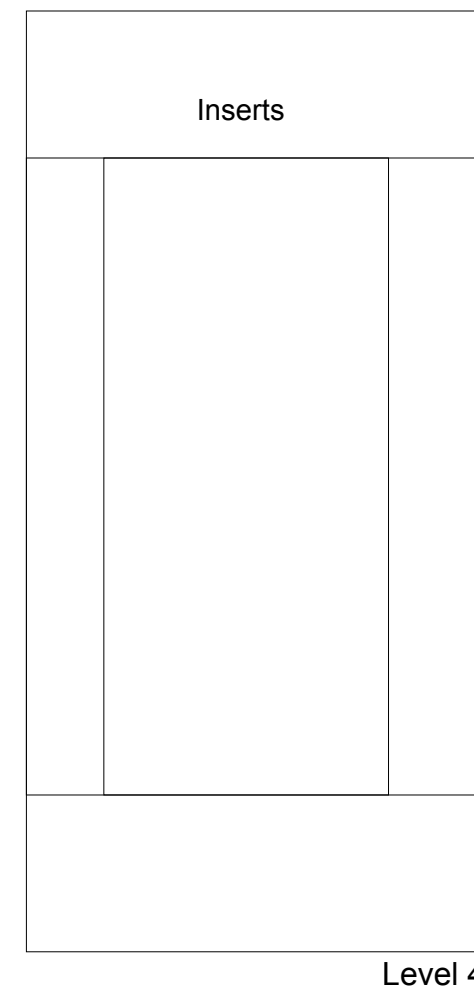
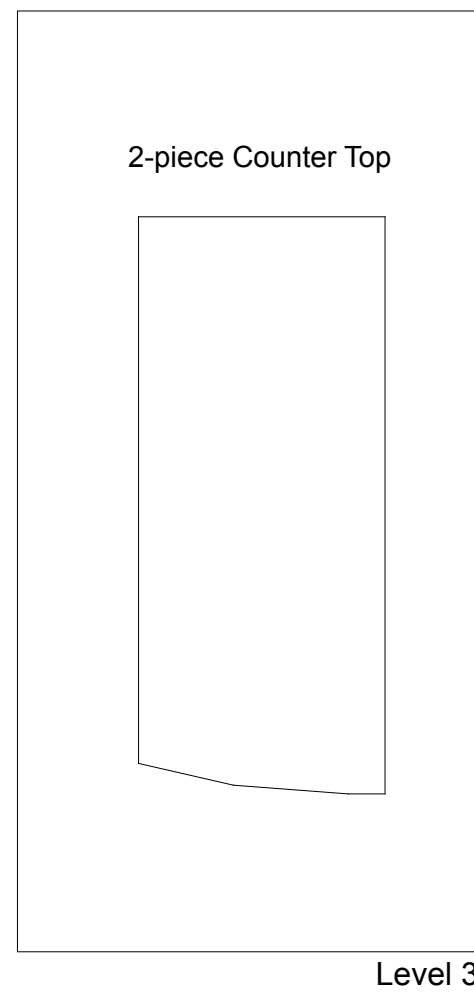
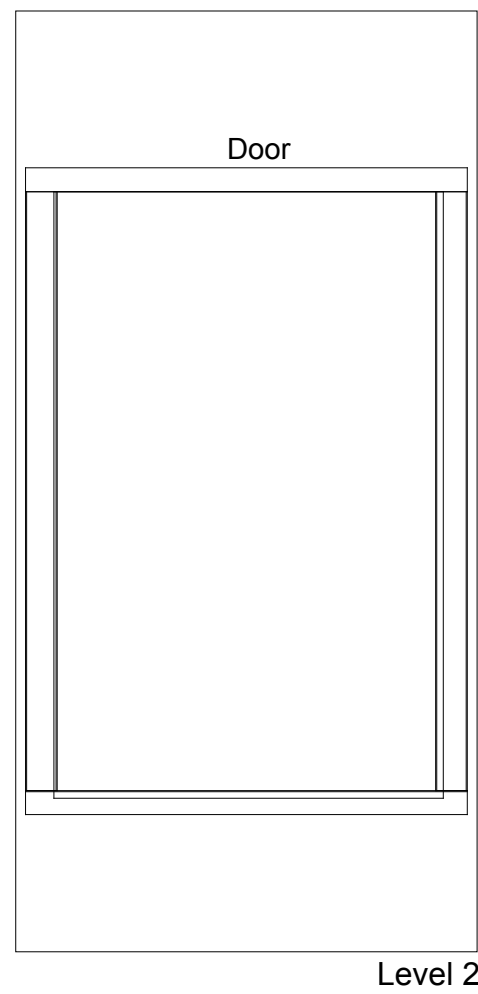
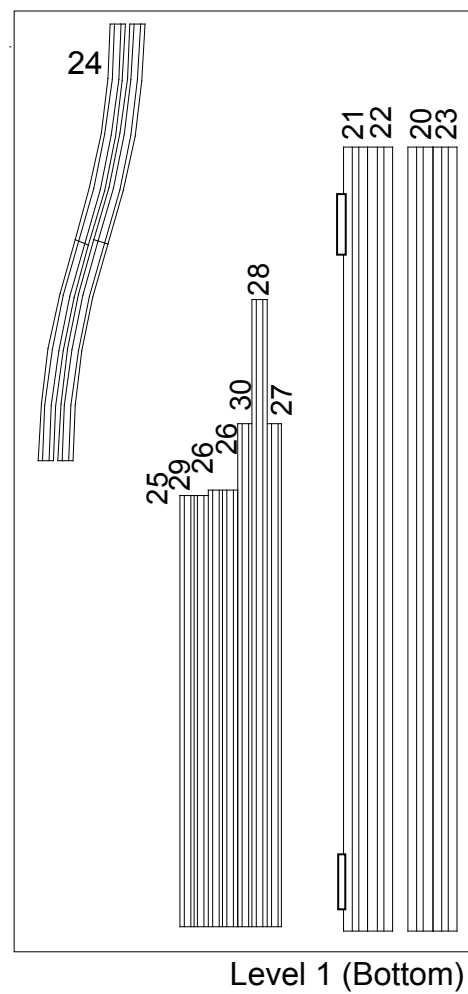

WHEN DISASSEMBLING ALUMINUM EXTRUSION, TIGHTEN ALL SETSCREWS AND LOCKS TO PREVENT LOSS DURING SHIPPING