

visionary[™]
DESIGNS

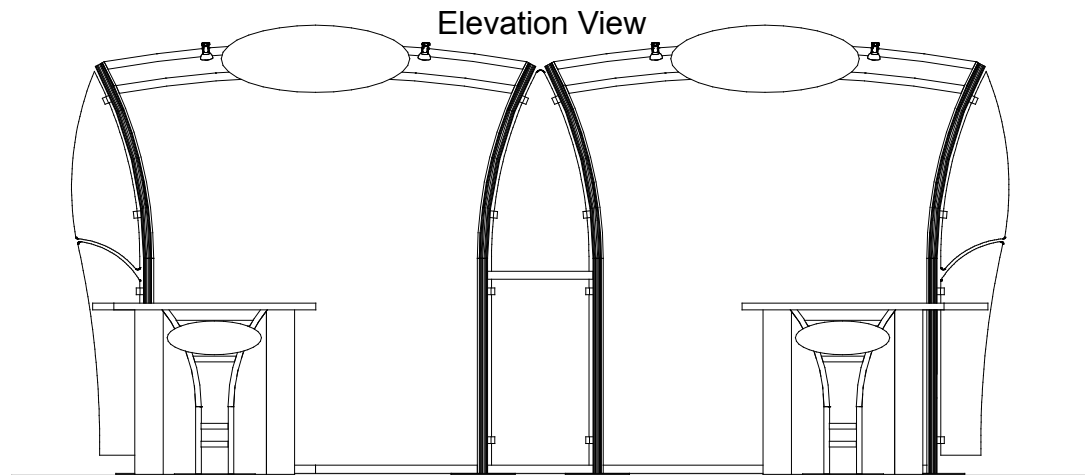

WHEN DISASSEMBLING ALUMINUM EXTRUSION, TIGHTEN ALL SETSCREWS AND LOCKS TO PREVENT LOSS DURING SHIPPING

visionary™ DESIGNS

Using Your Setup Instructions

The Visionary Designs Setup Instructions are created specifically for your configuration. They are laid out sequentially, including an exploded view of the entire display, and then a logical series of detailed steps to assemble the main structure and components. We encourage you to study the instructions **before** attempting to assemble your exhibit.

Each page reminds you to tighten the setscrews after disassembling your exhibit to prevent loss of the locks and setscrews (see below in RED). This is **VERY IMPORTANT**.

Cleaning and Packing Your Display

- 1) Use care when cleaning aluminum extrusion or acrylic inserts. Use only non-abrasive cleaners.
- 2) When cleaning laminate inserts or countertops, use mild cleansers and a soft material such as cotton.
- 3) Keep all display components away from extreme heat and long exposure to sunlight to avoid warping and fading.
- 4) Retain all packing material. It will make re-packing much easier and will reduce the likelihood of shipping damage.



The Tool

Most Visionary Designs exhibits can be assembled with the supplied Hex Key Tool. Occasionally, a flat head screwdriver may be required.



Typical Connection

Most horizontal extrusion connections have a patented expandable lock. This lock inserts into the groove of an opposing extrusion. Tightening the lock with the Hex Key Tool expands the lock and creates a strong positive connection.



Typical Connection (cont'd)

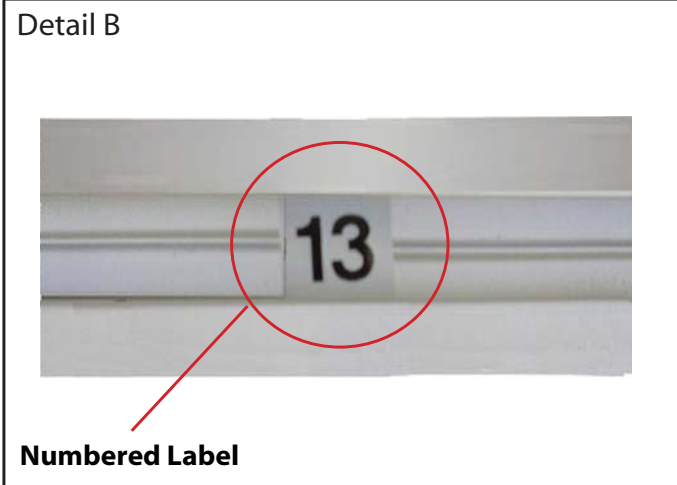

Numbered Label

Each extrusion contains a numbered label which corresponds with setup instructions. The label is located within a groove of the extrusion (when possible). With Visionary Designs the labels contain Black numbers unless otherwise specified.



Horizontal Inline Connection (remove only one setscrew)

Remove only (1) setscrew when disassembling. Replace setscrew in extrusion after assembling it. Before packing, replace setscrew in extrusion to avoid losing it.

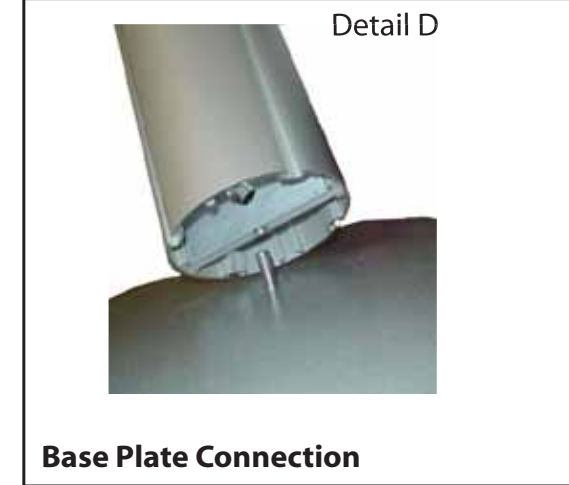

Base Plate Connection

Attach base plate to round or square vertical extrusion using the bolt provided. Be careful not to strip the threads.

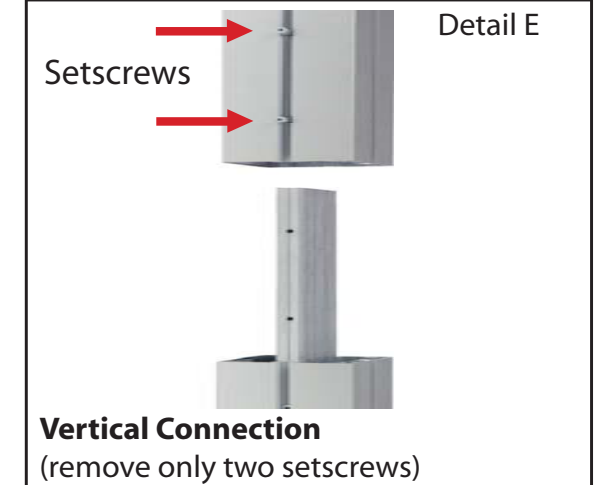

Vertical Connection
(remove only two setscrews)

When vertical extrusions are packed in portable cases rather than crates or tubs, they must be broken down into smaller sections which then require assembly.

Remove only (2) setscrews when disassembling. Replace setscrews in extrusion after assembling it. Before packing, replace setscrews in extrusion to avoid losing them.

WHEN DISASSEMBLING ALUMINUM EXTRUSION, TIGHTEN ALL SETSCREWS AND LOCKS TO PREVENT LOSS DURING SHIPPING

866.652.2100

Steps:

- 1) Attach lights to top of backwall as shown.
- 2) Attach graphic headers to velcro on front of [8a & 8b] as shown.
- 3) Attach wings to A-10 clamps on side as shown.
- 4) Place counter tops on top of extrusion [9 & 10] as shown.
- 5) Attach monitor mount as shown in *Monitor Mount Attachment* detail.

*** Monitor Mount Attachment**

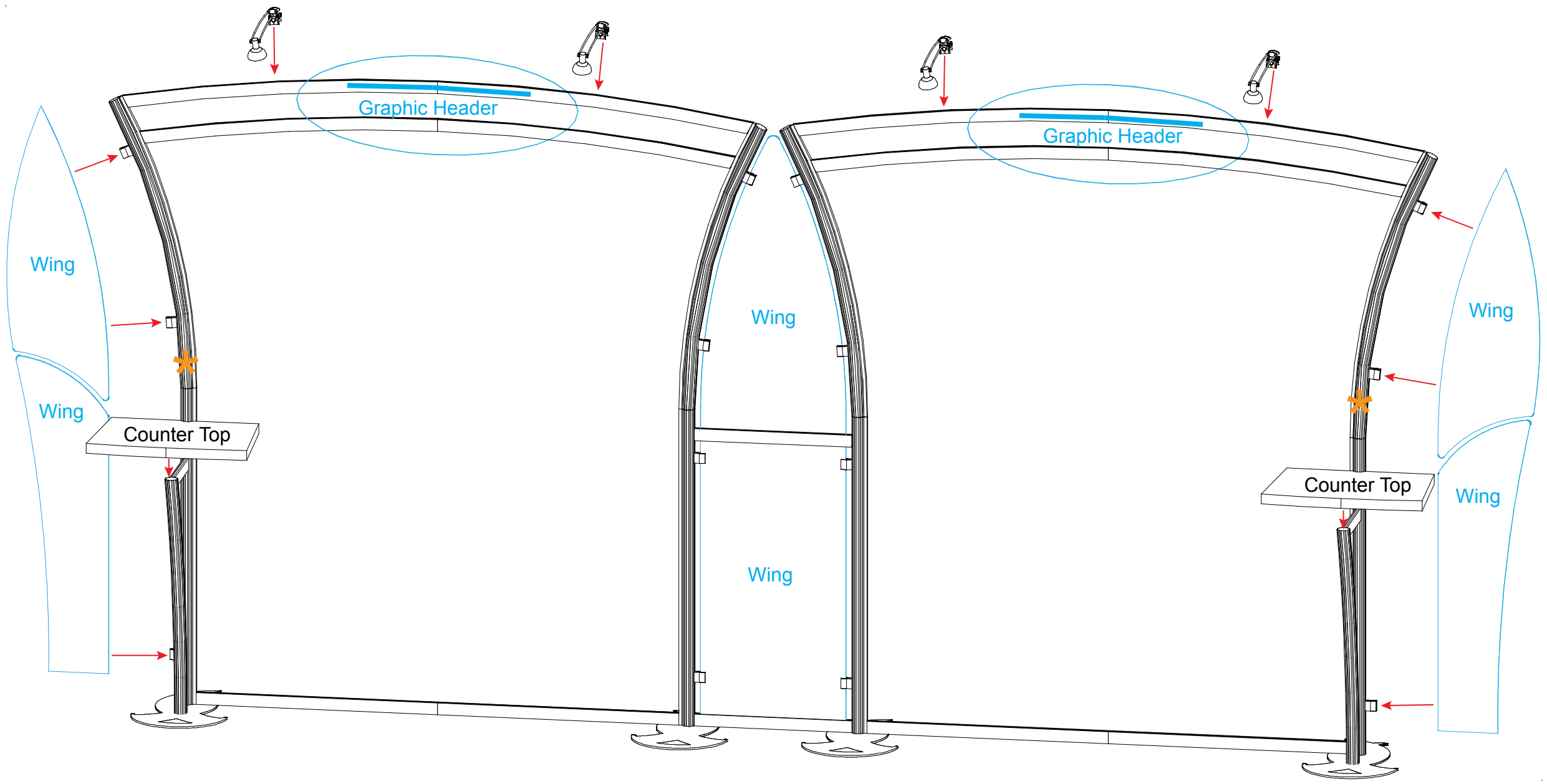
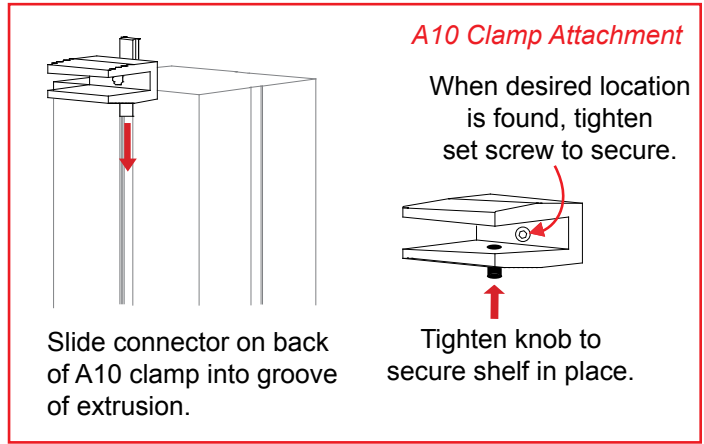
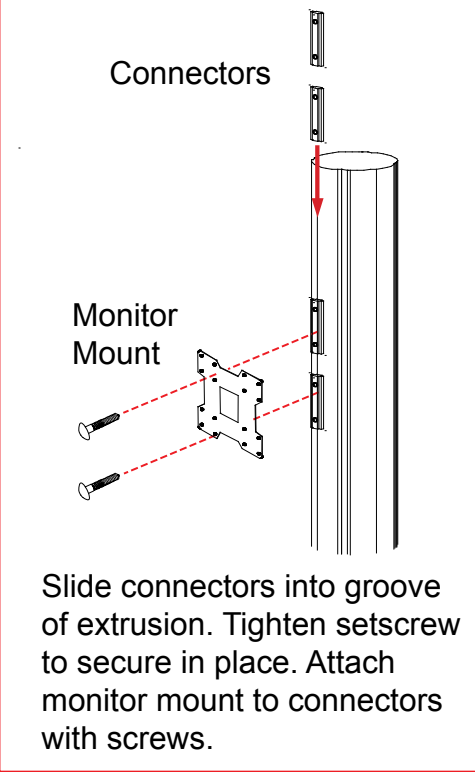

WHEN DISASSEMBLING ALUMINUM EXTRUSION, TIGHTEN ALL SETSCREWS AND LOCKS TO PREVENT LOSS DURING SHIPPING

866.652.2100

Panel	Description
1	5.75"r X 38"h Quarter Curve Panel
2	19"w x 38"h Flat Panel
3	5.75"r X 38"h Quarter Curve Panel
4	5.75"r X 38"h Quarter Curve Panel
5	19"w x 38"h Flat Panel w/Door
6	5.75"r X 38"h Quarter Curve Panel

Item	Description
1	Custom Base Plate
2	38"h Curved Round Vertical - Counter Support - Left side
3	38"h Curved Round Vertical - Counter Support - Right side
4	7" Lower Tapered Horizontal extrusion
5	8" Middle Tapered Horizontal extrusion
6	16.5" Upper Tapered Horizontal extrusion

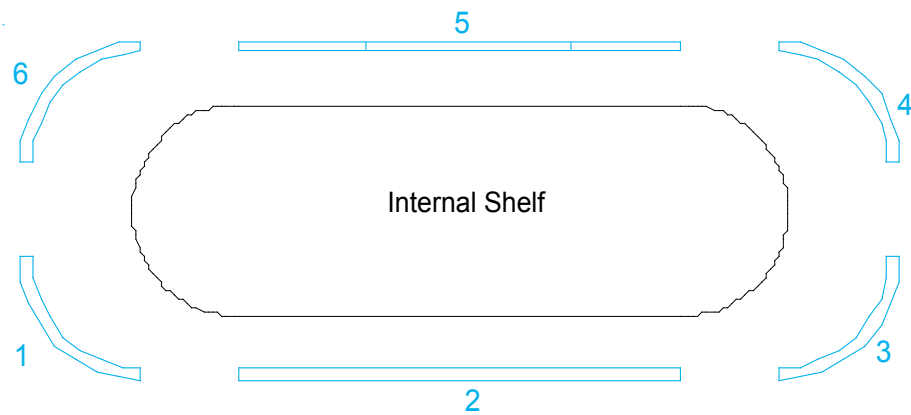

LT Pedestal Assembly

- 1) Assemble panels together starting with 1 in numerical order.
- 2) Attach Internal Shelf with provided shelf supports.

Steps 1 & 2 - LT Details:

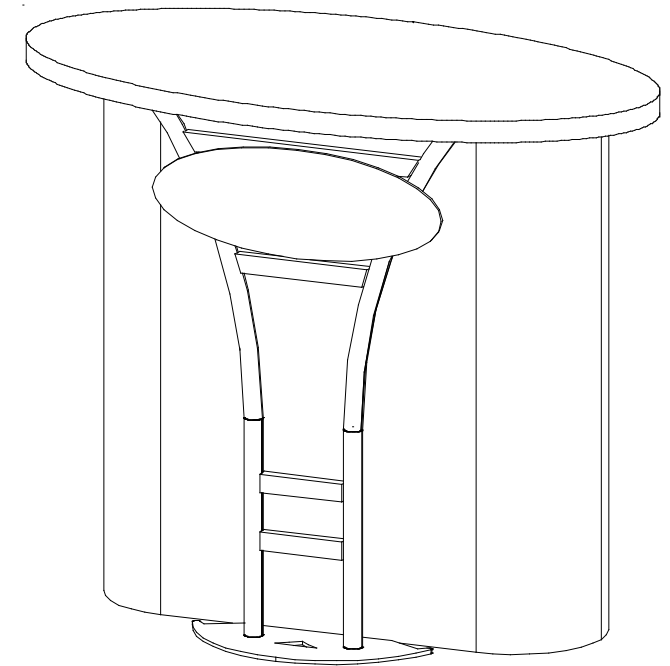
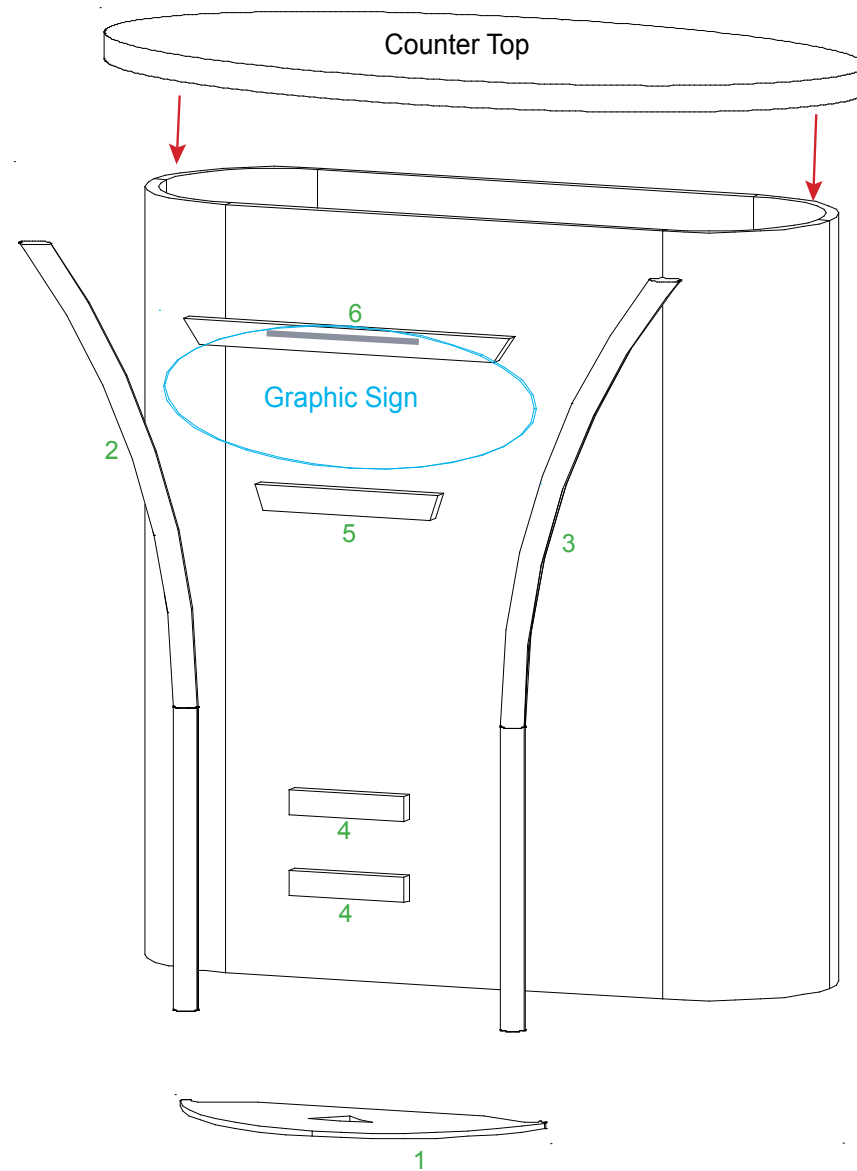
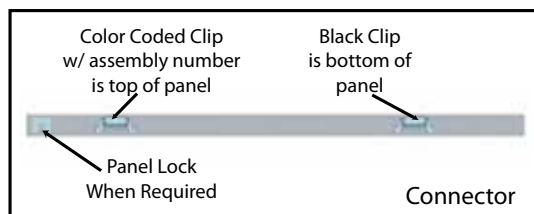
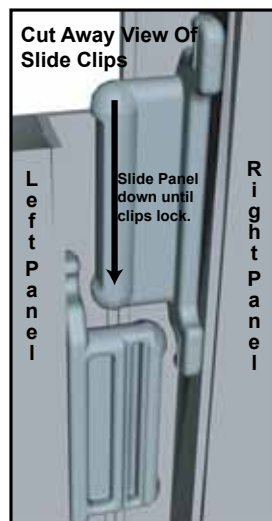
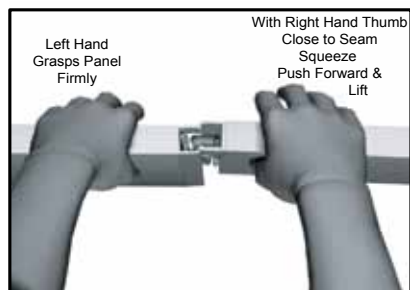

Front Aluminum portion of Pedestal Assembly

- 3) Attach Verticals [2 & 3] to Base Plate [1].
NOTE: Base Plate Centered and Flush with Back LT Portion of Pedestal.
- 4) Attach horizontals [4,5 & 6] between Verticals [2 & 3] as shown.
- 5) Place counter top on top of assembled pedestal as shown.
- 6) Attach graphic sign to Velcro on horizontal [6].

WHEN DISASSEMBLING ALUMINUM EXTRUSION, TIGHTEN ALL SETSCREWS AND LOCKS TO PREVENT LOSS DURING SHIPPING

Top View of Each Level

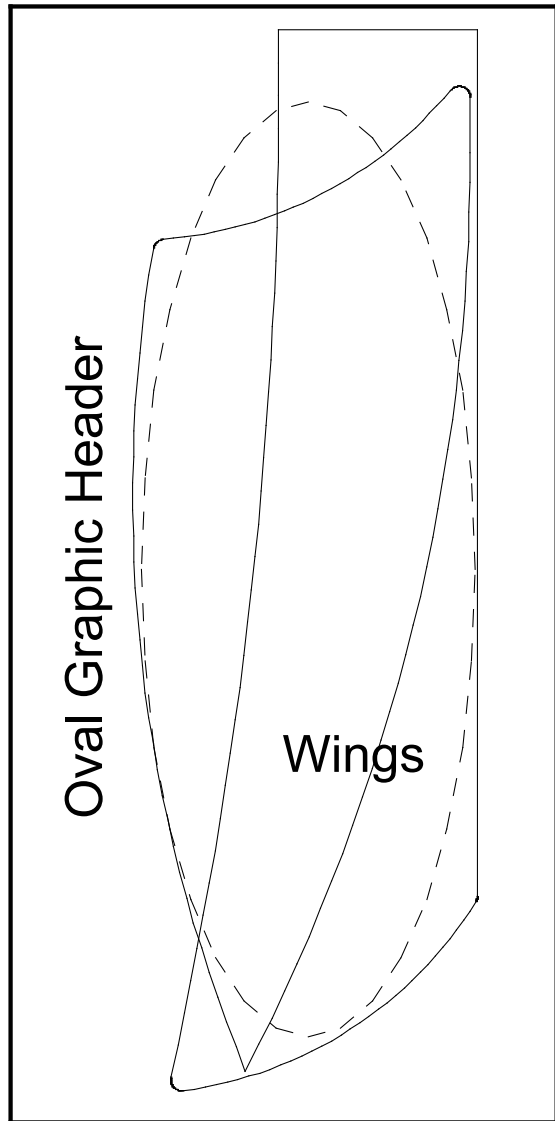

Level 1

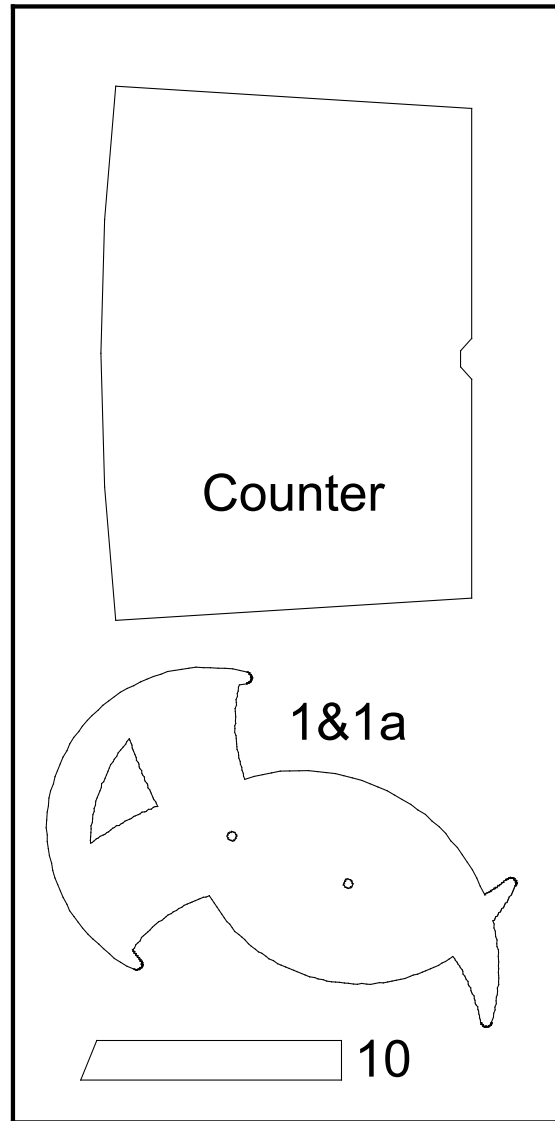

Level 2

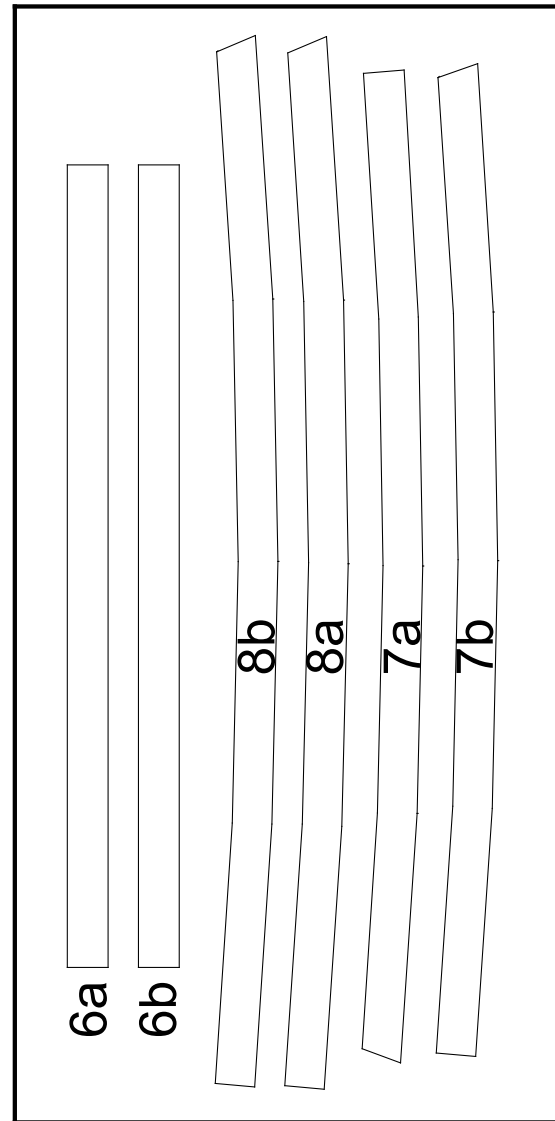

Level 3

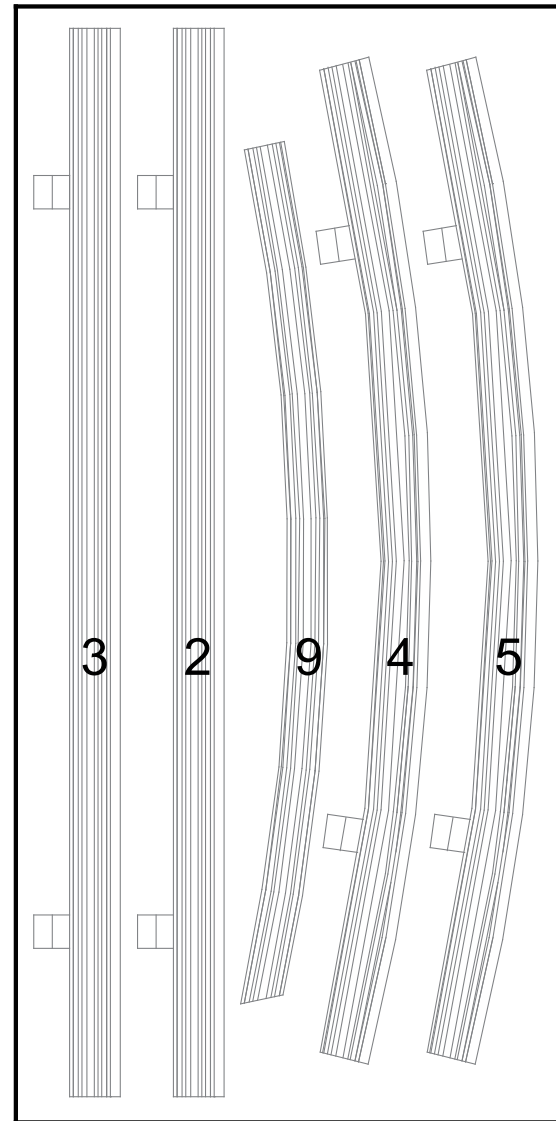

Level 4



WHEN DISASSEMBLING ALUMINUM EXTRUSION, TIGHTEN ALL SETSCREWS AND LOCKS TO PREVENT LOSS DURING SHIPPING

Top View of Each Level

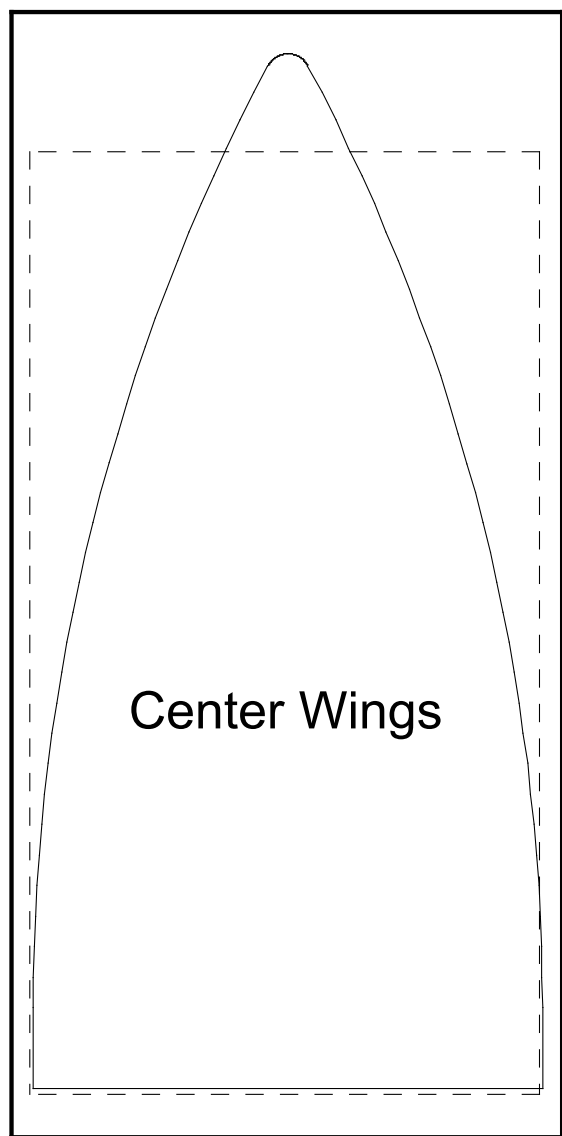

Level 1

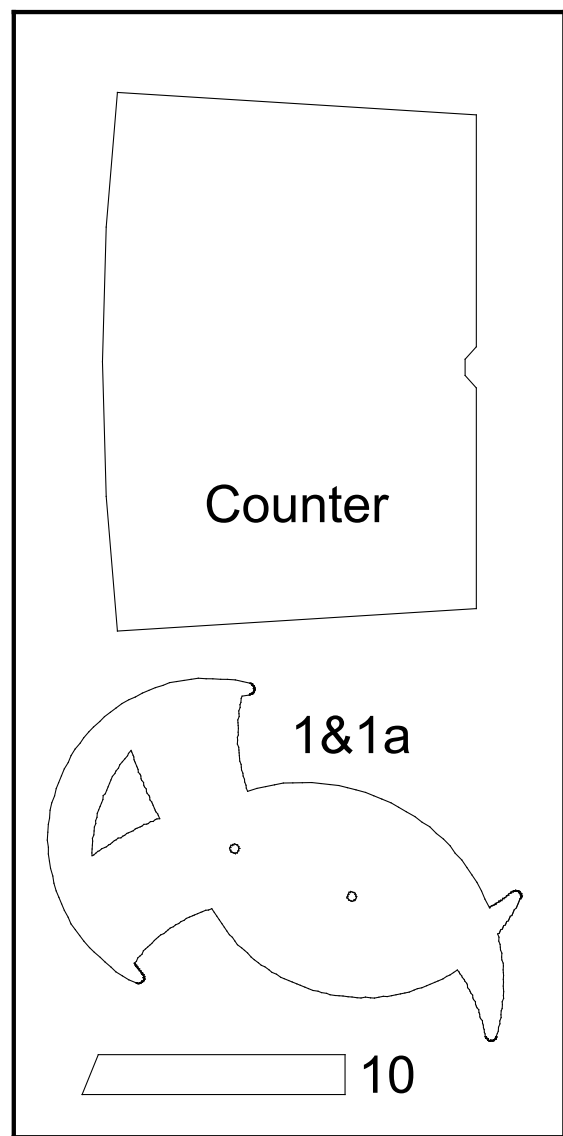

Level 2

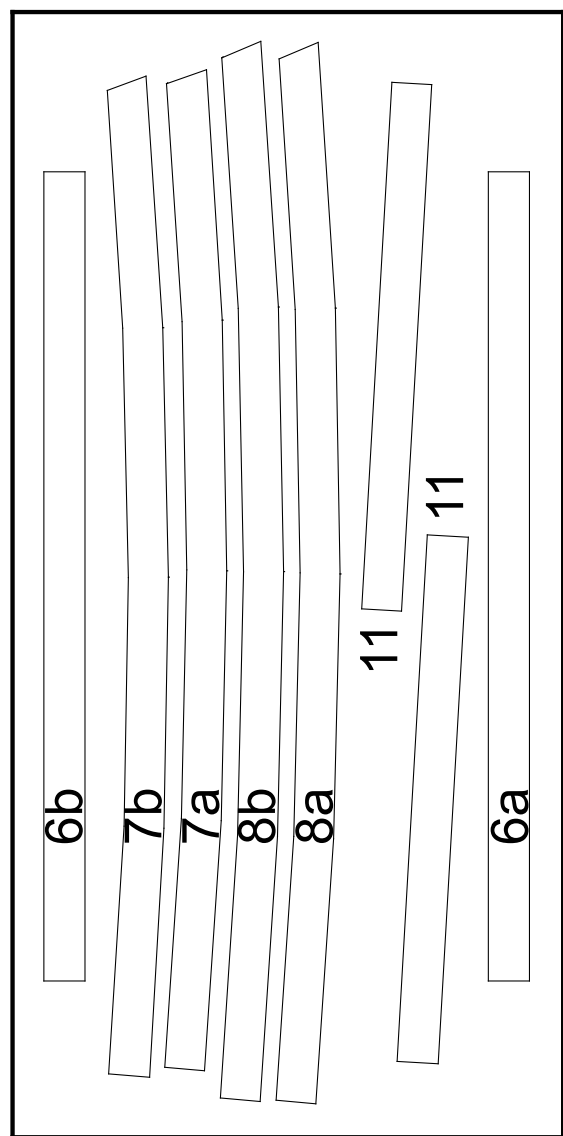

Level 3

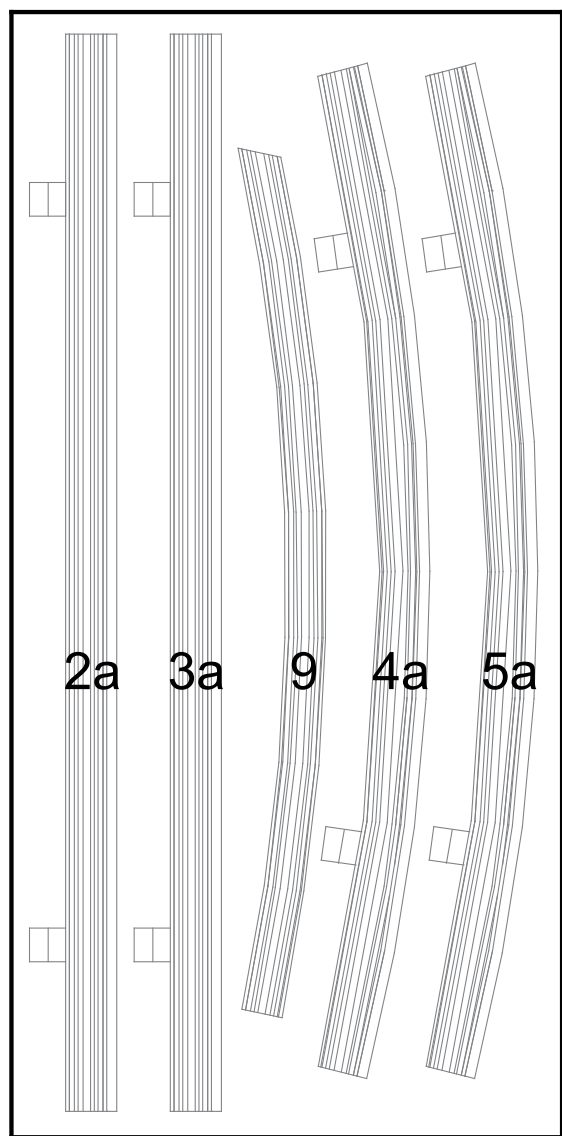

Level 4

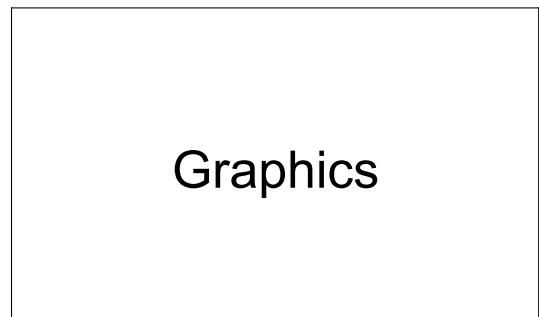

WHEN DISASSEMBLING ALUMINUM EXTRUSION, TIGHTEN ALL SETSCREWS AND LOCKS TO PREVENT LOSS DURING SHIPPING

Top View of Each Level

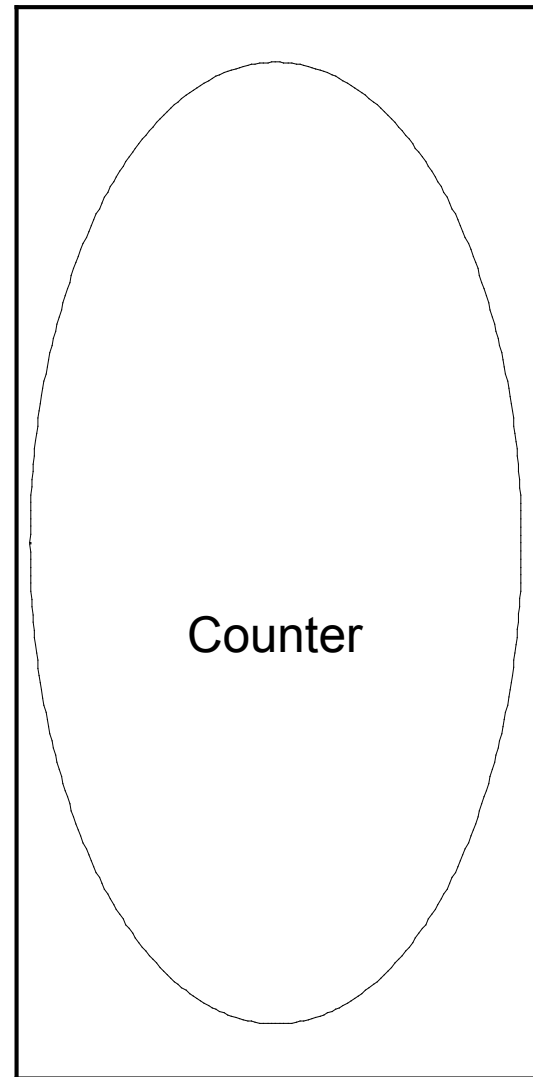

Level 1

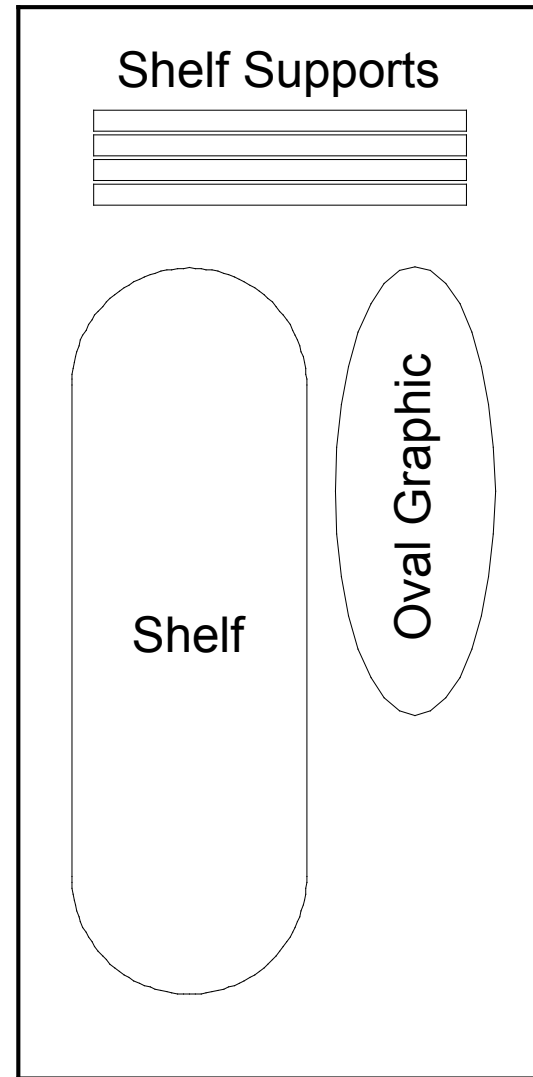

Level 2

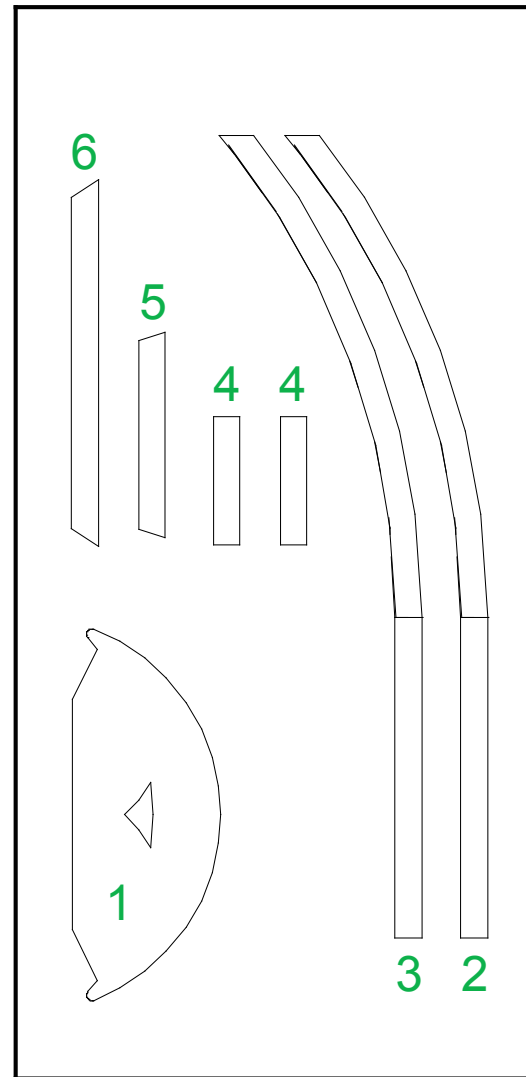

Level 3

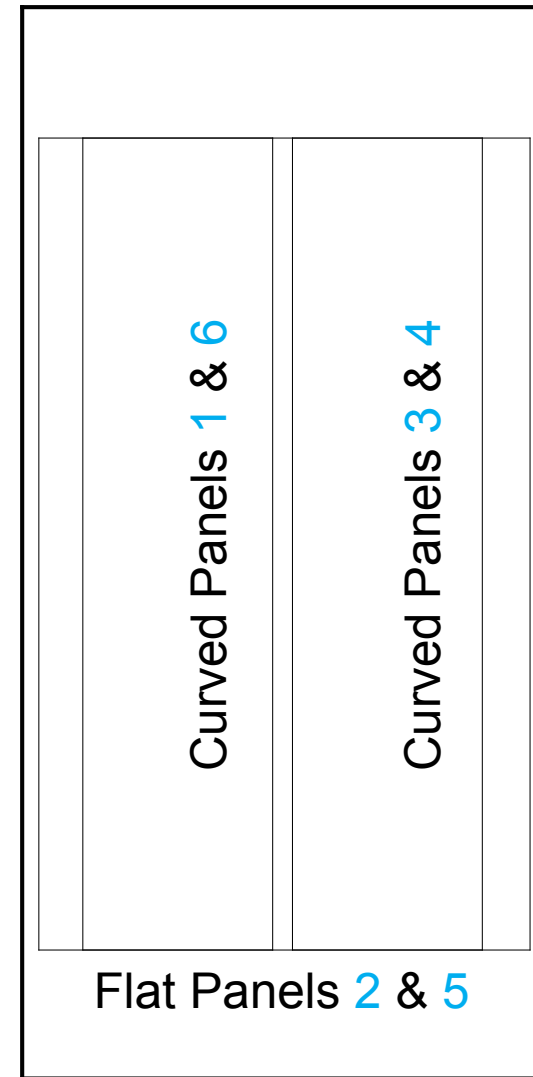

Level 4

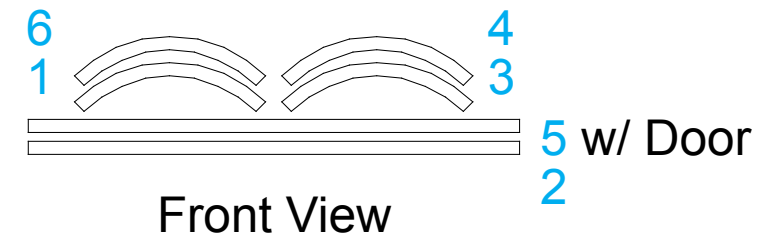

Front View

WHEN DISASSEMBLING ALUMINUM EXTRUSION, TIGHTEN ALL SETSCREWS AND LOCKS TO PREVENT LOSS DURING SHIPPING